

**Building Hardware  
Lever handle & Knob  
Req. test methods**

**BS EN  
1906:2002**



**Stainless steel  
Lever handle on  
rosette**



**MODEL: M01-SD079/GT01-SS**

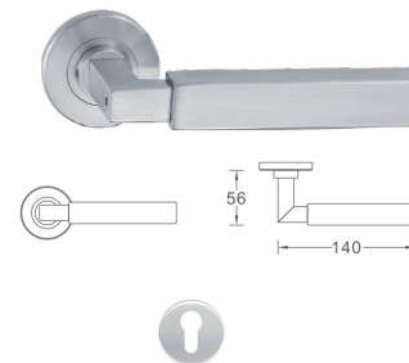

- 4.1.1 General : EN1906 shall be classified to the eight digit coding system described 4.1.2 to 4.1.9
- 4.1.2 Category of use : 1 to 4 = medium to high frequency
- 4.1.3 Durability : 6 = 0.1M, 7 = 0.2M cycles
- 4.1.4 Door mass : no classification
- 4.1.5 Fire resistance : 0 = not approved , 1 = suitable for use on fire/ smoke door
- 4.1.6 Safety : 0 = normal use, 1 = Safety use
- 4.1.7 Corrosion resistance : 0 = no defined, 4 = very high resistance
- 4.1.8 Security : 0 = not approved , 4 = extra high burglary resistance
- 4.1.9 Type of operation : A=spring assisted, b = spring-load, U = unsprung furniture

**Marco Polo Stainless Steel Lever Handle on Rosette**

**SPECIFICATION**

Materials : Grade 304 / 316

Handle Diameter : Grade 304— 19/22

Rosette Thickness : Grade 304—8mm

Spindle : 8mm square spindle

Option: half / split type

Door Thickness : 35-55mm

Lever Nr.	Escutcheon Nr.	Mat. & Finish
SD079	/ GT01	- SS

