

MARCO POLO



HEAVY DUTY US MORTISE
DOOR LOCK

M01-HD600-02-6401-US32/US32D



*The "MARCO POLO" Heavy Duty US
Mortise lock provides the ideal highest security
standard for your premises*



*Your Partner in Professional Finishing
Hardware*

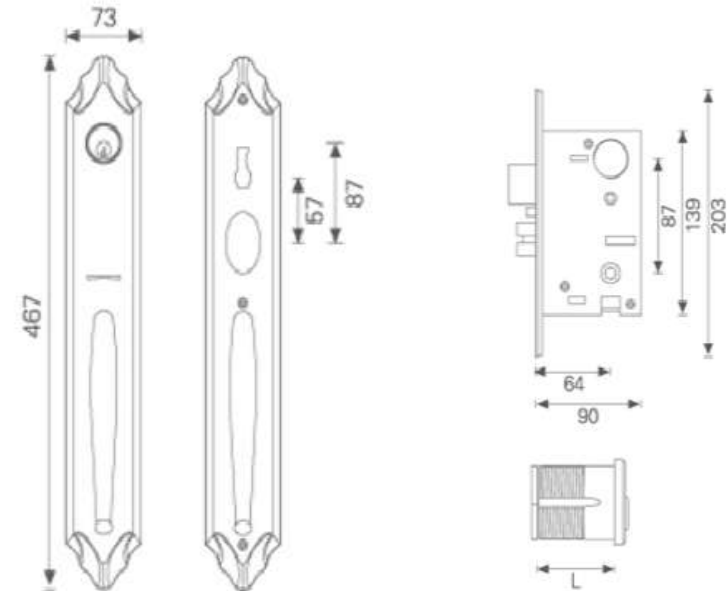

**COMPLETE WITH: 64 OR 70MM
BACKSET, U.S. MORTISE LOCK CASE
GRAB HANDLE SET IN EXTERIOR
MORTISE THREADED CYLINDER
SCREW PACK & DECORATED COVER
PLATE LEVER OR KNOB, 8X8MM
SPLIT TYPE SPINDLE KNOB WITH
4MM SPINDLE**



AMERICAN MORTISE GRAB HANDLE SET



PRODUCT SPECIFICATIONS:

- Finish Available: US3, US4, US5, US15, US26,
US26D
- Deadbolt: 1"(25mm)throw 2 pcs. Hardened
steel rod
- Latch Bolt: Standard 3/4"(18mm)x 1"(25mm)
extension throw
- Latch Backset: STD. 64mm, OPT. 70mm, 90mm
- Latch Face Plate: Square cornered 1-3/8"(32mm)
x 8 1/4"(204mm)
- Strike: Half lip strike 1-7/8"(47mm) x 4-
3/4"(119mm)
- Cylinder and Keys: M=solid Brass Dimple cylinder with
3 nickel plated keys
N=solid Brass traditional cylinder
with 3 nickel plated keys
- Handing: Left / Right handed
- Door Thickness: Standard: 1-5/8"(38mm) to 2"(51mm)
Option: 2"(51mm) to 2-3/8"(61mm)
Specify when order



MANILA CAPITCO CORPORATION

Unit 6B, 2nd Floor DOLMAR Bldg. U.N. Avenue
Paco Manila, Metro Manila Philippines

Phone: 02.3536302/ 02.5333072

Telefax: 02.3536301

E-mail: manila@capitco.com.hk